



**VISLIGHTING**  
维士照明®

# OUTDOOR LED LIGHTING CATALOG

户外灯具画册

东莞市荣嘉节能环保设备有限公司

Dongguan Rongjia Energy -saving and Environmental Protection equipment Co., Ltd



• 东莞市荣嘉节能环保设备有限公司成立2009年，注册资本人民币3050万元，“维士照明”商标持有者，是一家集工业、亮化、道路照明、灯光捕鱼等灯具研发、生产、销售为一体的高新技术企业。产品通过了ISO9001:2008认证、CE认证、3C认证、CQC认证以及国家防爆认证。总部设立于号称世界工厂的东莞市，公司有专业的实验室检测仪器设备，严格按照ISO9001标准的要求，建立质量管理体系的同事持续有效地进行规范化运作，产品种类多种多样，以满足不同客户的需求。



• 在2016年，我司与中国科学院合作，研发了水上水下LED集鱼灯系列产品，应用于渔业航海特种照明，是全国首家获得专利设计的产品。我司为中科院独家授权生产LED集鱼灯的厂家，产品采用全铝外壳、散热结构特别设计，保证灯具工作时热量快速扩散，提高灯具寿命、可靠性。

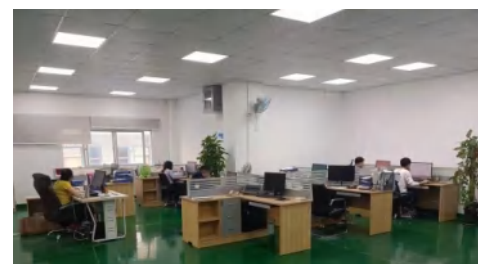

• 维士照明一直致力于工业厂房照明改造，为各种环境异常恶劣的制造行业（如造纸行业、玻璃行业、金属行业、汽车行业等）提供品质稳定、能耗极低的LED灯具，为中国节能环保事业做出贡献，在很多工业行业的照明节能改造中成为当之无愧的领先品牌。



**VIS Lighting**, is an internationally leading supplier of integral lighting solutions for professional outdoor building lighting applications. For more than 10 years, VIS Lighting has been developing innovative, custom lighting solutions that meet extremely exacting requirements in terms of ergonomics, economic efficiency and environmental compatibility and also deliver aesthetic added value. As an innovation leader, VIS Lighting supplies an extensive range of premium luminaires and lighting control systems for various professional building lighting application areas:

- Industry and Engineering
- Façades and architecture
- Education and Science
- Hotel and Wellness
- Art and Culture
- Health and Care

**International leader**

VIS Lighting has an international customer presence in 13 countries and commercial agencies in more than 50 other countries. The company has its roots in China but sets great store by international contacts in order to maintain its worldwide network of specialists and design partners in the lighting sector.

**The emotional effect of light**

VIS Lighting uses integral lighting solutions to create lighting scenes that make it possible to experience the interplay between light and architecture in all its diverse complexity. The combined use of luminaires, lighting management systems is geared towards the architecture of a building and the particular application situation.

**QUALITY**

For over 10 years, the VIS Lighting brand has been synonymous with innovation, unique product and service quality and superior design. The brand has always been underpinned by knowledge of lighting and a profound understanding of its effects on people. Aspiring to create the best light for people and the environment, VIS Lighting provides customized solutions featuring measurable added value.

**Research and development**

VIS Lighting is a leader in lighting research thanks to its close collaboration with international experts and scientific institutions. VIS Lighting is constantly pushing ahead with new product innovations based on up-to-the-minute research findings, combined with unique application know-how and extensive technological expertise. The result is a new quality of light: intelligent lighting solutions that adjust to individual needs and save resources in every respect.





# VISLIGHTING

## 维士照明

## CONTENTS 目录

---

### **LED LIGHTING 产品系列**

1. LED FLOOD LIGHT SERIES 投光灯系列
2. LED TUNNEL LIGHT SERIES 隧道灯系列
3. LED STADIUM LIGHT SERIES 球场灯系列
4. LED STREET LIGHT SERIES 路灯系列
5. LED EXPLOSION PROOF LIGHT SERIES 防爆灯系列
6. LED HEAT RESISTANCE LIGHT SERIES 耐高温灯系列
7. LED HIGH BAY LIGHT SERIES 工矿灯系列
8. LED WALL WASHER LIGHT SERIES 洗墙灯系列
9. LED TUBE LIGHT SERIES 灯管系列
10. LED PANEL LIGHT SERIES 面板灯系列

### **PROJECTS DISPLAY 产品案例展示**

### **CERTIFICATE 荣誉证书**



**VISLIGHTING**  
维士照明®

# LED FLOOD LIGHT

Power 透镜款系列泛光灯

100-600W

High lighting efficiency 150lm/w  
PC lens, Uniform distribution of lights

Meanwell driver  
5 years warranty





Features

外壳材料 Housing:	Aluminium
灯珠品牌 LED Brands:	Philips / Osram / Bridgelux
光效 Luminous efficiency:	150-160 lm/W
显色指数 CRI:	70/ 80
色温 Colour temp.:	2700k - 7000K
驱动 LED Driver:	Taiwan MeanWell
功率因数 Power Factor:	>0.95
总谐波失真 THD of Driver:	≤9%
输入电压 Input Voltage:	AC 110-265 V 50-60 Hz
防护等级 Protection:	IP 65
工作环境温度 Working temp.:	-40 ~ +65°C
使用寿命 Life span:	> 50,000 h
电器类型 Appliance:	Class I
光束角 Beam angle:	80x160°/85x155°/100*155° 130°/ 90°

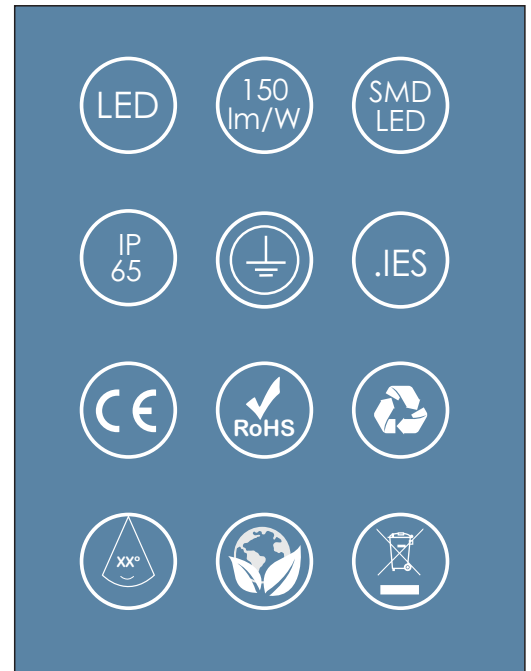

型号 MODEL NUMBER	瓦数 WATTAGE	LED 数量 LED PCS	光通总量 NOMINAL FLUX	净重 N.W.	毛重 G.W.	包装尺寸 (CM) CRT. SIZE (CM)
VIS-PFL-100W	100 W	128	15000 LM	3.0 KG	3.3 KG	36*26*12
VIS-PFL-150W	150 W	256	24000 LM	4.6 KG	5.1 KG	37*28*17
VIS-PFL-200W	200 W	256	30000 LM	4.6 KG	5.1 KG	37*28*17
VIS-PFL-300W	300 W	384	45000 LM	6.1 KG	6.7 KG	37*35*17
VIS-PFL-400W	400 W	512	60000 LM	8.3 KG	9.0 KG	37*46*17
VIS-PFL-500W	500 W	640	75000 LM	10.0 KG	10.8 KG	37*56*17
VIS-PFL-600W	600 W	768	90000 LM	11.3 KG	12.25 KG	37*66*17





Photometry

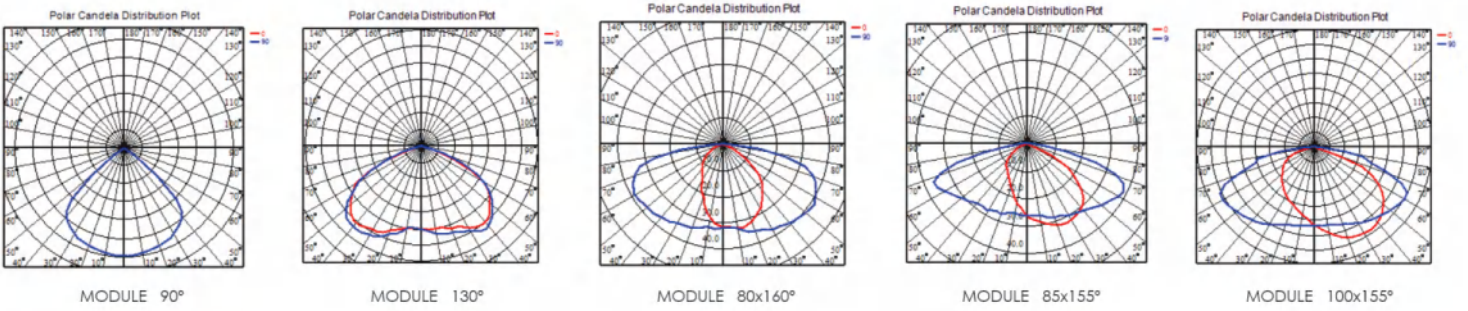

Dimensiones/ Measures

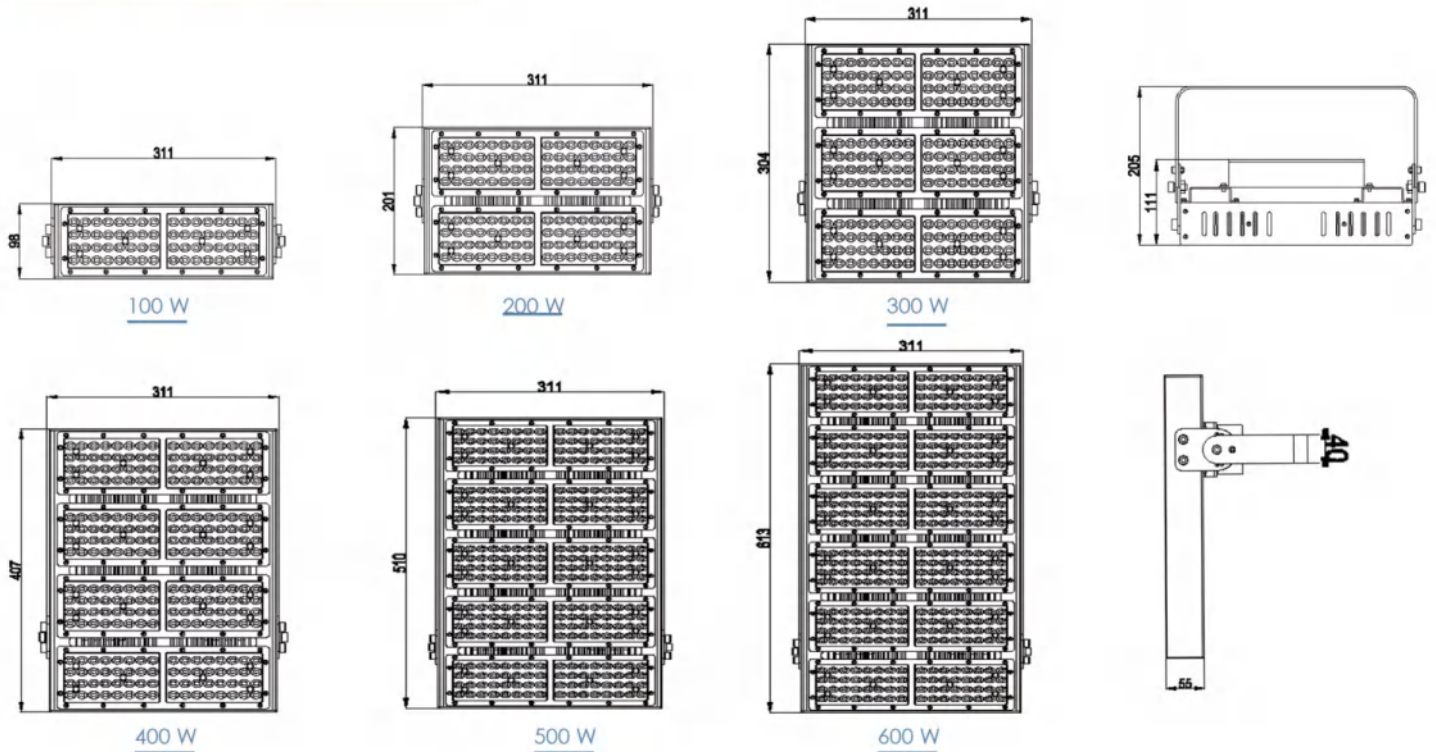

**VISLIGHTING**  
维士照明®

# LED FLOOD LIGHT

Power 反光杯款系列泛光灯

100-600W

High lighting efficiency 130lm/w

Reflector, high illumination  
long irradiation distance

Meanwell driver  
5 years warranty







Features

外壳材料 Housing:	Aluminium
灯珠品牌 LED Brands:	Philips / Osram / Bridgelux
光效 Luminous efficiency:	120-130 lm/W
显色指数 CRI:	70/ 80
色温 Colour temp.:	2700k - 7000K
驱动 LED Driver:	Taiwan MeanWell
功率因数 Power Factor:	>0.95
总谐波失真 THD of Driver:	≤9%
输入电压 Input Voltage:	AC 110-265 V 50-60 Hz
防护等级 Protection:	IP 65
工作环境温度 Working temp.:	-40 ~ +65°C
使用寿命 Life span:	> 50,000 h
电器类型 Appliance:	Class I
光束角 Beam angle:	80x60°

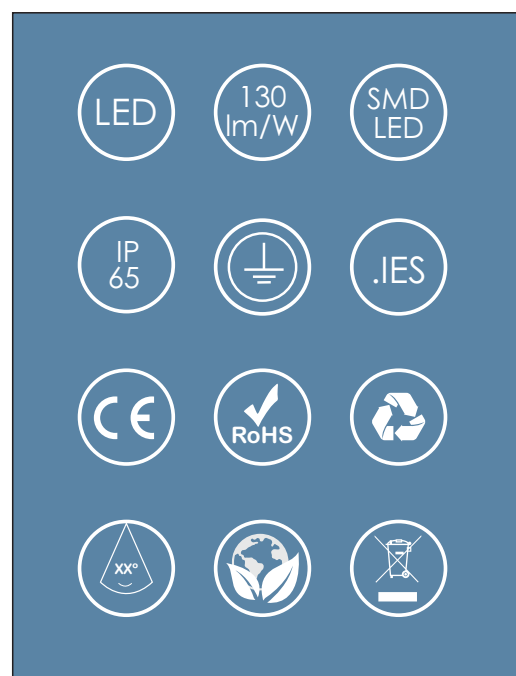

型号 MODEL NUMBER	瓦数 WATTAGE	LED 数量 LED PCS	光通总量 NOMINAL FLUX	净重 N.W.	毛重 G.W.	包装尺寸 (CM) CRT. SIZE (CM)
VIS-PFR-100W	100 W	120	12500 LM	3.0 KG	3.3 KG	36*26*12
VIS-PFR-150W	150 W	240	19000 LM	4.6 KG	5.1 KG	37*28*17
VIS-PFR-200W	200 W	240	25000 LM	4.6 KG	5.1 KG	37*28*17
VIS-PFR-300W	300 W	360	37500 LM	6.1 KG	6.7 KG	37*35*17
VIS-PFR-400W	400 W	480	50000 LM	8.3 KG	9.0 KG	37*46*17
VIS-PFR-500W	500 W	600	62500 LM	10.0 KG	10.8 KG	37*56*17
VIS-PFR-600W	600 W	720	75000 LM	11.3 KG	12.25 KG	37*66*17



Photometry

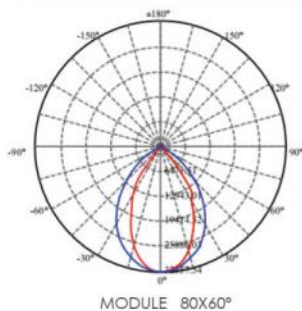

Dimensiones/ Measures

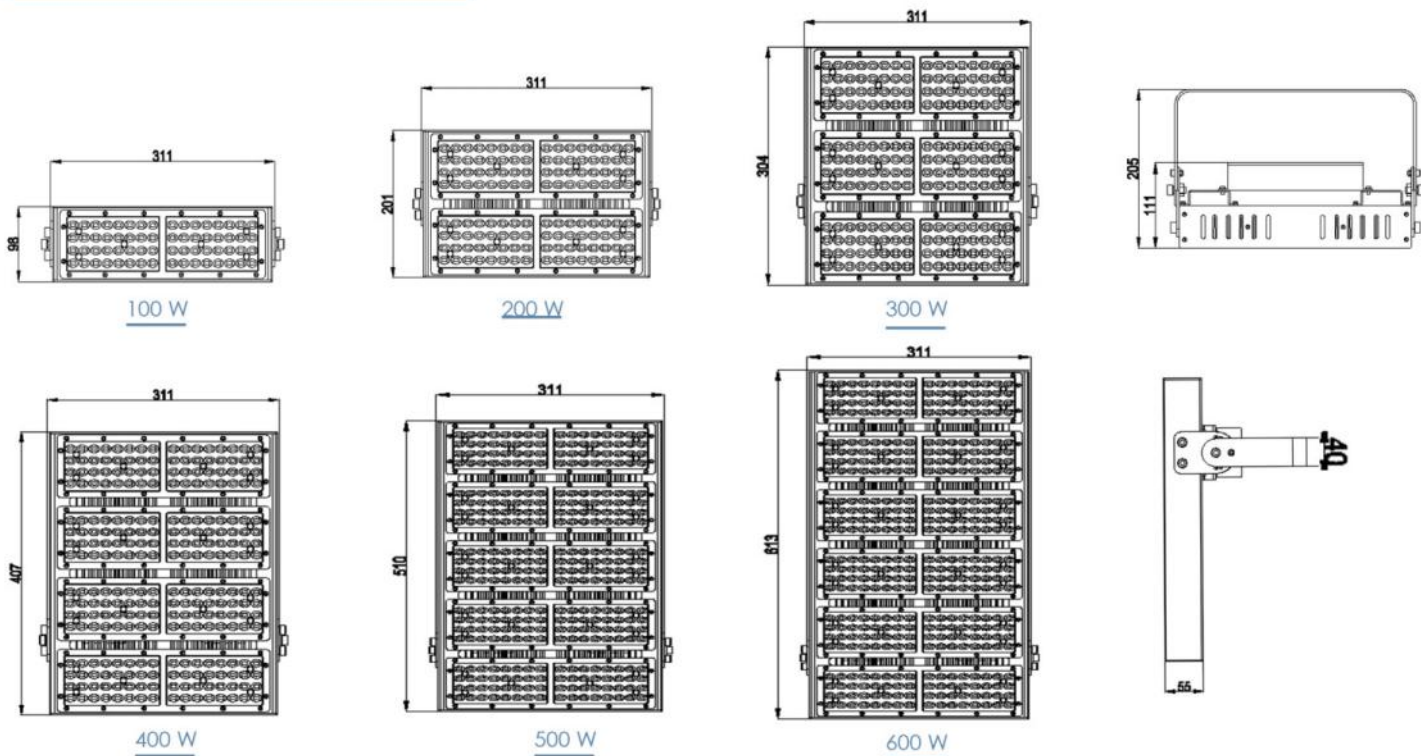

**VISLIGHTING**  
维士照明®

# LED FLOOD LIGHT

Force 系列泛光灯

## 100-200W

High lighting efficiency 135lm/w  
Meanwell driver built-in

Beam angle  
15°/30°/60°/90° option







## Features

外壳材料 Housing:	Aluminium
灯珠品牌 LED Brands:	Philips / Osram / Bridgelux
光效 Luminous efficiency:	135 lm/W
显色指数 CRI:	70/ 80
色温 Colour temp.:	2700k - 6500K
驱动 LED Driver:	Inventronics
功率因数 Power Factor:	>0.95
总谐波失真 THD of Driver:	≤9%
输入电压 Input Voltage:	AC 110-265 V 50-60 Hz
防护等级 Protection:	IP 66
工作环境温度 Working temp.:	-40 ~ +65°C
使用寿命 Life span:	> 50,000 h
电器类型 Appliance:	Class I
光束角 Beam angle:	15°/30°/60°/90°

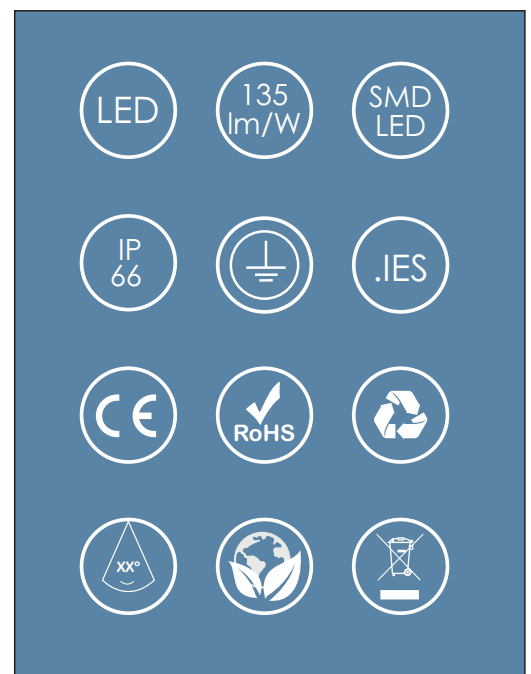

型号 MODEL NUMBER	瓦数 WATTAGE	光通总量 NOMINAL FLUX	净重 N.W.	毛重 G.W.	产品尺寸 (CM) PRODUCT SIZE (CM)
VIS-FFL-100W	100 W	13500 LM	3.9 KG	4.4 KG	42.5*27*5.2
VIS-FFL-150W	150 W	20250 LM	4.8 KG	5.4 KG	47.3*32*5.2
VIS-FFL-200W	200 W	27000 LM	5.7 KG	6.4 KG	47.3*37*5.2



## Features

外壳材料 Housing:	Aluminium
灯珠品牌 LED Brands:	Philips / Osram / Bridgelux
光效 Luminous efficiency:	135 lm/W
显色指数 CRI:	70/ 80
色温 Colour temp.:	2700k - 6500K
驱动 LED Driver:	Taiwan MeanWell
功率因数 Power Factor:	>0.95
总谐波失真 THD of Driver:	≤9%
输入电压 Input Voltage:	AC 100-277 V 50-60 Hz
防护等级 Protection:	IP 65
工作环境温度 Working temp.:	-30 ~ +60°C
使用寿命 Life span:	> 50,000 h
电器类型 Appliance:	Class I
光束角 Beam angle:	30°/60°/90°/ Type1/ Type2/Type3/Type4/Type5

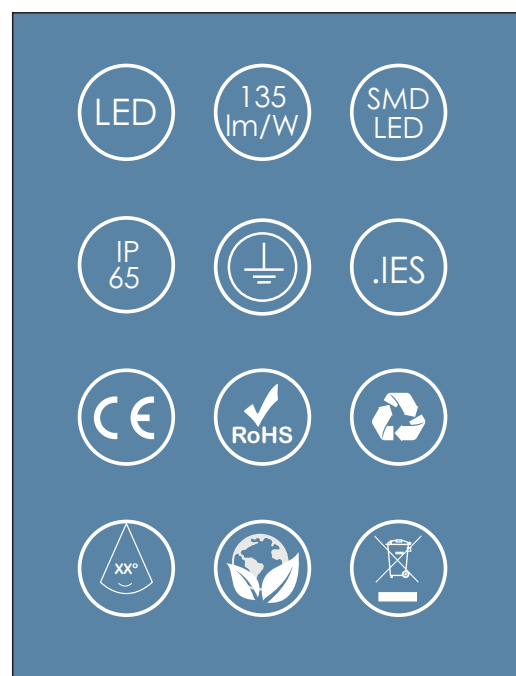

型号 MODEL NUMBER	瓦数 WATTAGE	光通总量 NOMINAL FLUX	净重 N.W.	毛重 G.W.	产品尺寸 (CM) PRODUCT SIZE (CM)
VIS-FFR-50W	50 W	6750 LM	2.0 KG	2.2 KG	31.5*22*5
VIS-FFR-80W	80 W	13500 LM	3.4 KG	3.7 KG	35.5*24.5*5.5
VIS-FFR-100W	100 W	20250 LM	3.7 KG	4.0 KG	40.5*29.5*6
VIS-FFR-150W	150 W	27000 LM	4.9 KG	5.2 KG	43.5*33*6
VIS-FFR-200W	200 W	32400 LM	5.3 KG	5.7 KG	47.5*36*6



## Features

外壳材料 Housing:	Aluminium
灯珠品牌 LED Brands:	Philips / Osram / Bridgelux
光效 Luminous efficiency:	135 lm/W
显色指数 CRI:	70/ 80
色温 Colour temp.:	2700k - 7000K
驱动 LED Driver:	Taiwan MeanWell
功率因数 Power Factor:	>0.95
总谐波失真 THD of Driver:	≤9%
输入电压 Input Voltage:	AC 110-265 V 50-60 Hz
防护等级 Protection:	IP 65
工作环境温度 Working temp.:	-40 ~ +65°C
使用寿命 Life span:	> 50,000 h
电器类型 Appliance:	Class I
光束角 Beam angle:	120*90°

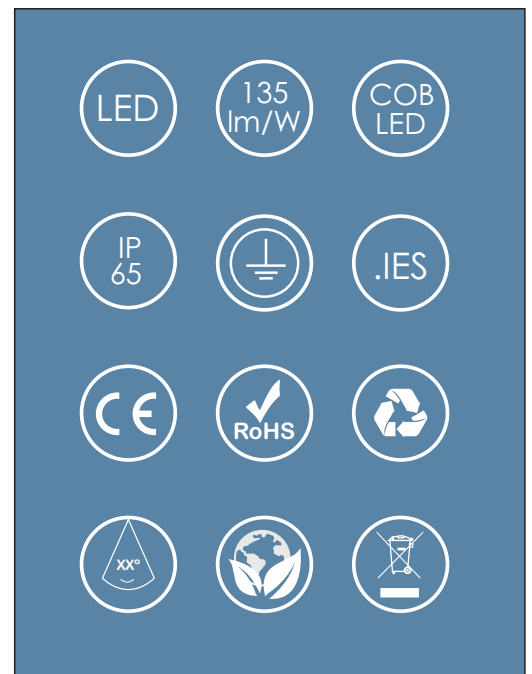

型号 MODEL NUMBER	瓦数 WATTAGE	光通总量 NOMINAL FLUX	净重 N.W.	毛重 G.W.	产品尺寸 (CM) PRODUCT SIZE (CM)
VIS-FFR-50W-01	50 W	6750 LM	1.5 KG	1.7 KG	25.8*26.6*6
VIS-FFR-80W-01	80 W	13500 LM	3.8 KG	4.1 KG	35.8*32.6*6
VIS-FFR-100W-01	100 W	20250 LM	3.7 KG	4.0 KG	35.8*32.6*6
VIS-FFR-150W-01	150 W	27000 LM	5.0 KG	5.4 KG	43.8*36.1*6
VIS-FFR-200W-01	200 W	32400 LM	5.5 KG	6.0 KG	43.8*39.6*6
VIS-FFR-300W-01	300 W	40500 LM	6.9 KG	7.5 KG	46*50.5*8



**VISLIGHTING**  
维士照明®

# LED TUNNEL LIGHT

Force 系列隧道灯

50-250W

High lighting efficiency 135lm/w  
Meanwell driver built-in

Beam angle  
30°/60°/90° option

Waterproof IP65





## Features

外壳材料 Housing:	Aluminium
灯珠品牌 LED Brands:	Philips / Osram / Bridgelux
光效 Luminous efficiency:	125 lm/W
显色指数 CRI:	70/ 80
色温 Colour temp.:	2700k - 7000K
驱动 LED Driver:	Taiwan MeanWell
功率因数 Power Factor:	>0.95
总谐波失真 THD of Driver:	≤9%
输入电压 Input Voltage:	AC 110-265 V 50-60 Hz
防护等级 Protection:	IP 65
工作环境温度 Working temp.:	-40 ~ +65°C
使用寿命 Life span:	> 50,000 h
电器类型 Appliance:	Class I
光束角 Beam angle:	60° / 90° / 120°

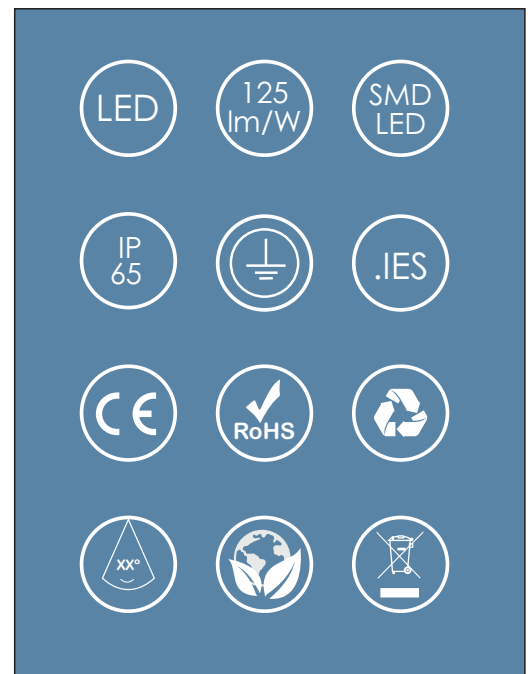

型号 MODEL NUMBER	瓦数 WATTAGE	光通总量 NOMINAL FLUX	净重 N.W.	毛重 G.W.	产品尺寸 (CM) PRODUCT SIZE (CM)
VIS-FFC-50W	50 W	6250 LM	1.8 KG	2.0 KG	35*7.5*7.5
VIS-FFC-100W	100 W	12500 LM	2.8 KG	3.5 KG	35*15*7.5
VIS-FFC-150W	150 W	18750 LM	4.2 KG	4.9 KG	35*24*7.5
VIS-FFC-200W	200 W	25000 LM	5.6 KG	6.3 KG	35*31.5*7.5
VIS-FFC-250W	250 W	31250 LM	5.6 KG	6.3 KG	35*39.5*7.5



## Features

外壳材料 Housing:	Aluminium
灯珠品牌 LED Brands:	Philips / Osram / Bridgelux
光效 Luminous efficiency:	130 lm/W
显色指数 CRI:	70/ 80
色温 Colour temp.:	2700k - 7000K
驱动 LED Driver:	Taiwan MeanWell
功率因数 Power Factor:	>0.95
总谐波失真 THD of Driver:	≤9%
输入电压 Input Voltage:	AC 110-265 V 50-60 Hz
防护等级 Protection:	IP 65
工作环境温度 Working temp.:	-40 ~ +65°C
使用寿命 Life span:	> 50,000 h
电器类型 Appliance:	Class I
光束角 Beam angle:	60° / 90° / 120°

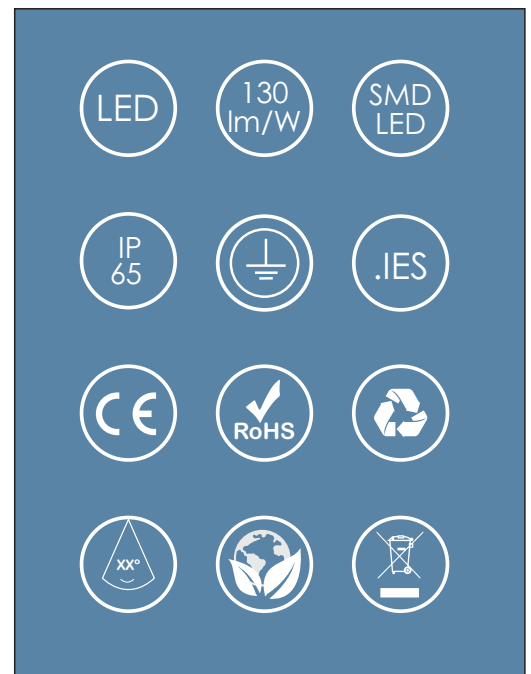

型号 MODEL NUMBER	瓦数 WATTAGE	光通总量 NOMINAL FLUX	净重 N.W.	毛重 G.W.	产品尺寸 (CM) PRODUCT SIZE (CM)
VIS-FFC-100W-01	100 W	13000 LM	2.8 KG	3.5 KG	35*35*17
VIS-FFC-150W-01	150 W	19500 LM	4.2 KG	4.9 KG	42*41*18
VIS-FFC-200W-01	200 W	26000 LM	5.6 KG	6.3 KG	47*47*20





## Features

外壳材料 Housing:	Aluminium
灯珠品牌 LED Brands:	Philips / Osram / Bridgelux
光效 Luminous efficiency:	150 lm/W
显色指数 CRI:	70/ 80
色温 Colour temp.:	2700k - 7000K
驱动 LED Driver:	Taiwan MeanWell
功率因数 Power Factor:	>0.95
总谐波失真 THD of Driver:	≤9%
输入电压 Input Voltage:	AC 110-265 V 50-60 Hz
防护等级 Protection:	IP 65
工作环境温度 Working temp.:	-40 ~ +65°C
使用寿命 Life span:	> 50,000 h
电器类型 Appliance:	Class I
光束角 Beam angle:	60° / 90° / 120°

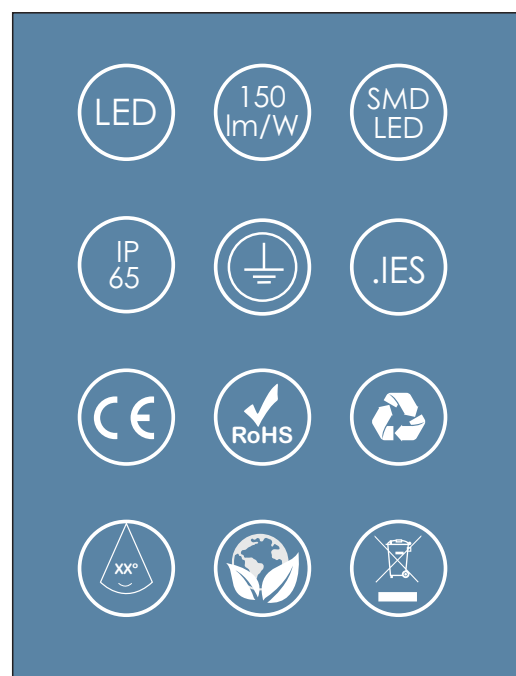

型号 MODEL NUMBER	瓦数 WATTAGE	光通总量 NOMINAL FLUX	净重 N.W.	毛重 G.W.	产品尺寸 (CM) PRODUCT SIZE (CM)
VIS-FFC-100W-02	100 W	15000 LM	4.3 KG	4.5 KG	35*35*17
VIS-FFC-150W-02	150 W	22500 LM	5.1 KG	5.4 KG	42*41*18
VIS-FFC-200W-02	200 W	30000 LM	6.2 KG	6.6 KG	47*47*20

**VISLIGHTING**  
维士照明®

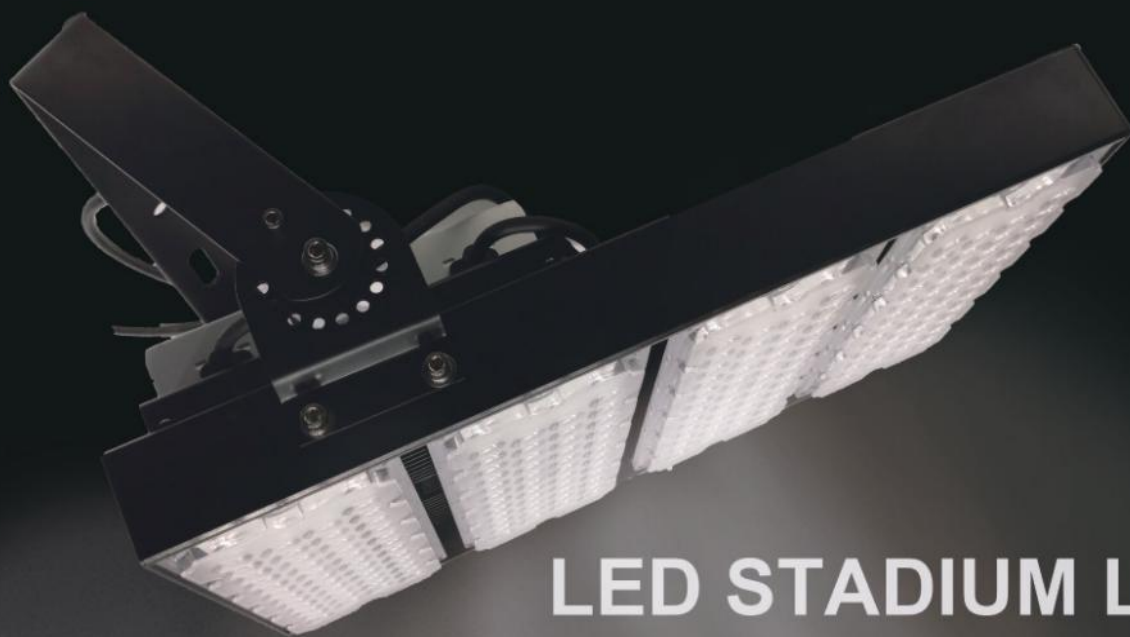

## LED STADIUM LIGHT

20/40 Beam angle

5050 led chips

120w/240w/360w/480w/600w option





### Features

外壳材料 Housing:	Aluminium
灯珠品牌 LED Brands:	Bridgelux 5050
光效 Luminous efficiency:	150 lm/W
显色指数 CRI:	70/ 80
色温 Colour temp.:	2700k - 6500K
驱动 LED Driver:	Taiwan MeanWell
功率因数 Power Factor:	>0.95
总谐波失真 THD of Driver:	≤9%
输入电压 Input Voltage:	AC 110-265 V 50-60 Hz
防护等级 Protection:	IP 65
工作环境温度 Working temp.:	-40 ~ +65°C
使用寿命 Life span:	> 50,000 h
电器类型 Appliance:	Class I
光束角 Beam angle:	20° / 40°

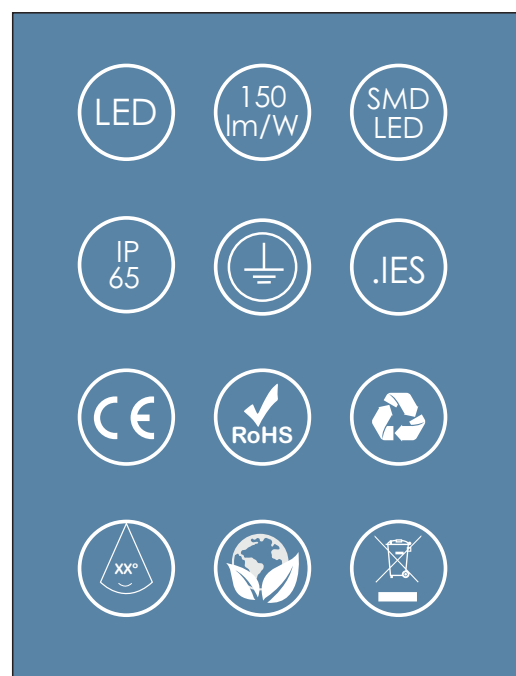

型号 MODEL NUMBER	瓦数 WATTAGE	光通总量 NOMINAL FLUX	净重 N.W.	毛重 G.W.	产品尺寸 (CM) PRODUCT SIZE (CM)
VIS-PFS-120W	120 W	18000 LM	3.3 KG	3.5 KG	31*12.3*5.6
VIS-PFS-240W	240 W	36000 LM	5.3 KG	5.5 KG	31*24.6*5.6
VIS-PFS-360W	360 W	54000 LM	8.3 KG	9.0 KG	31*37.6*5.6
VIS-PFS-480W	480 W	57600 LM	10.0 KG	10.8 KG	31*50.6*5.6
VIS-PFS-600W	600 W	90000 LM	12.0 KG	13.0 KG	31*63.6*5.6





**Features**

外壳材料 Housing:	Aluminium
灯珠品牌 LED Brands:	Philips / Osram / Bridgelux
光效 Luminous efficiency:	150 lm/W
显色指数 CRI:	70/ 80
色温 Colour temp.:	2700k - 6500K
驱动 LED Driver:	Taiwan MeanWell
功率因数 Power Factor:	>0.95
总谐波失真 THD of Driver:	≤9%
输入电压 Input Voltage:	AC 110-265 V 50-60 Hz
防护等级 Protection:	IP 66
工作环境温度 Working temp.:	-40 ~ +65°C
使用寿命 Life span:	> 50,000 h
电器类型 Appliance:	Class I
光束角 Beam angle:	20°/40°/45°/60°

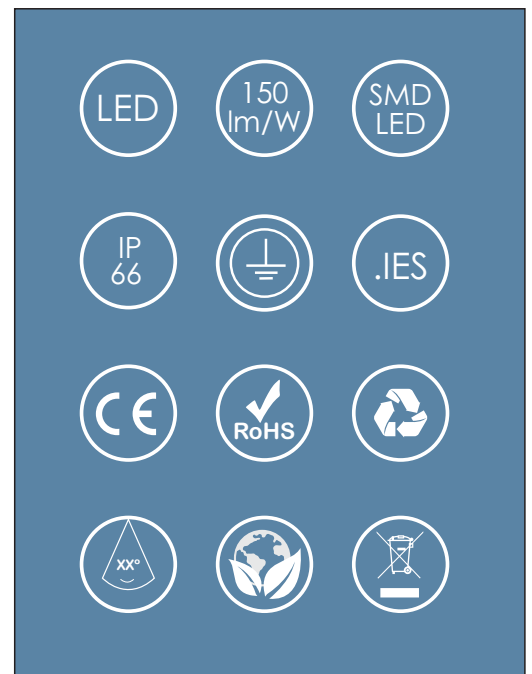

型号 MODEL NUMBER	瓦数 WATTAGE	光通总量 NOMINAL FLUX	净重 N.W.	毛重 G.W.	产品尺寸 (CM) PRODUCT SIZE (CM)
VIS-PFS-250W-01	250 W	37500 LM	5.5 KG	6.8 KG	59*19*20
VIS-PFS-500W-01	500 W	75000 LM	13.4 KG	15.2 KG	63*40.5*28
VIS-PFS-750W-01	750 W	112500 LM	18.1 KG	21.5 KG	63*40.5*43.5
VIS-PFS-1000W-01	1000 W	150000 LM	23.3 KG	26.2 KG	63*40.5*59
VIS-PFS-1250W-01	1250 W	187500 LM	28.5 KG	32.5 KG	63*40.5*74.5
VIS-PFS-1500W-01	1500 W	225000 LM	33.5 KG	37.5 KG	63*40.5*90

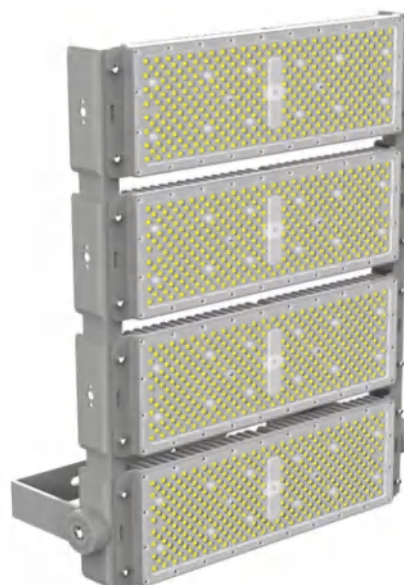

### Features

外壳材料 Housing:	Aluminium
灯珠品牌 LED Brands:	Philips / Osram / Bridgelux
光效 Luminous efficiency:	145 lm/W
显色指数 CRI:	70/ 80
色温 Colour temp.:	2700k - 7000K
驱动 LED Driver:	Taiwan MeanWell
功率因数 Power Factor:	>0.95
总谐波失真 THD of Driver:	≤9%
输入电压 Input Voltage:	AC 110-265 V 50-60 Hz
防护等级 Protection:	IP 66
工作环境温度 Working temp.:	-40 ~ +65°C
使用寿命 Life span:	> 50,000 h
电器类型 Appliance:	Class I
光束角 Beam angle:	30°/60°/90°

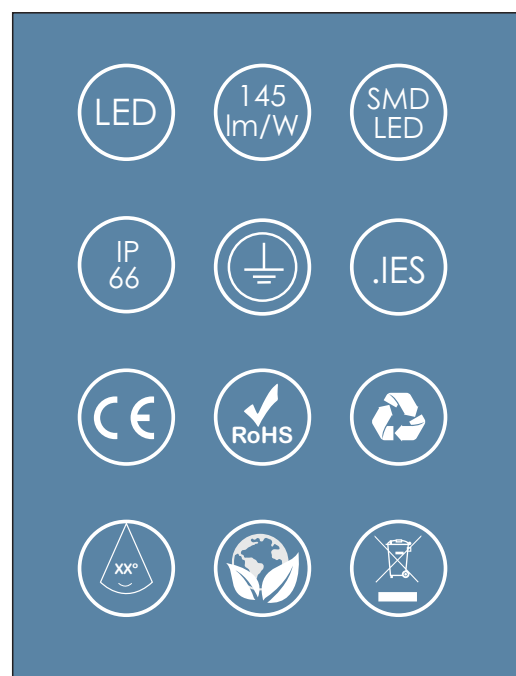

型号 MODEL NUMBER	瓦数 WATTAGE	光通总量 NOMINAL FLUX	净重 N.W.	毛重 G.W.	产品尺寸 (CM) PRODUCT SIZE (CM)
VIS-PFS-200W-02	200 W	29000 LM	5.5 KG	6.5 KG	18*50.5*15
VIS-PFS-400W-02	400 W	58000 LM	9.2 KG	11.2 KG	18*50.5*32
VIS-PFS-600W-02	600 W	87000 LM	12.8 KG	14.3 KG	18*50.5*49
VIS-PFS-800W-02	800 W	116000 LM	16.5 KG	18.5 KG	18*50.5*66
VIS-PFS-1200W-02	1200 W	174000 LM	25.0 KG	28.5 KG	25*98.5*32
VIS-PFS-1600W-02	1600 W	261000 LM	33.8 KG	36.4 KG	25*98.5*66



**Features**

外壳材料 Housing:	Aluminium
灯珠品牌 LED Brands:	Philips / Osram / Bridgelux
光效 Luminous efficiency:	150 lm/W
显色指数 CRI:	70/ 80
色温 Colour temp.:	2700k - 7000K
驱动 LED Driver:	Taiwan MeanWell
功率因数 Power Factor:	>0.95
总谐波失真 THD of Driver:	≤9%
输入电压 Input Voltage:	AC 100-300 V 50-60 Hz
防护等级 Protection:	IP 66
工作环境温度 Working temp.:	-40 ~ +65°C
使用寿命 Life span:	> 50,000 h
电器类型 Appliance:	Class I
光束角 Beam angle:	10°/25°/45°/60°

型号 MODEL NUMBER	瓦数 WATTAGE	光通总量 NOMINAL FLUX	净重 N.W.	毛重 G.W.	产品尺寸 (CM) PRODCUT SIZE (CM)
VIS-PFS-400W-03	400 W	60000 LM	17.5 KG	19.6 KG	42.8*32.6*32.6
VIS-PFS-600W-03	600 W	90000 LM	21.6 KG	24.3 KG	49*46*33
VIS-PFS-1200W-03	1200 W	180000 LM	32.6 KG	37.2 KG	64.5*62*38



**VISLIGHTING**  
维士照明®



## LED STREET LIGHT

路灯系列

50-150W

Glass lens :T1,T2,T3 option  
Meanwell driver built-in



### Features

外壳材料 Housing:	Aluminium
灯珠品牌 LED Brands:	Philips / Osram / Bridgelux
光效 Luminous efficiency:	135 lm/W
显色指数 CRI:	70/ 80
色温 Colour temp.:	3000k - 6500K
驱动 LED Driver:	Taiwan MeanWell
功率因数 Power Factor:	>0.95
总谐波失真 THD of Driver:	≤9%
输入电压 Input Voltage:	AC 110-265 V 50-60 Hz
防护等级 Protection:	IP 66
工作环境温度 Working temp.:	-40 ~ +65°C
使用寿命 Life span:	> 50,000 h
光束角 Beam angle:	65*150°/80*150°

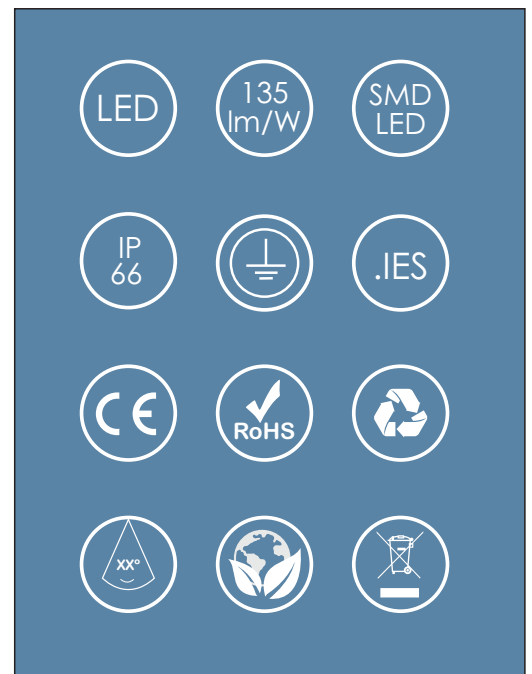

型号 MODEL NUMBER	瓦数 WATTAGE	光通总量 NOMINAL FLUX	净重 N.W.	毛重 G.W.	产品尺寸 (CM) Product. SIZE (CM)
VIS-FLL- 50W	50 W	6750 LM	3.5 KG	4.3 KG	55.5*20*10.5
VIS-FLL-100W	100 W	13500 LM	4.2 KG	6.6 KG	61.5*23.3*10
VIS-FLL-150W	150 W	20250 LM	5.1 KG	7.9 KG	67.5*26*10
VIS-FLL-200W	200 W	27000 LM	6.3 KG	8.5 KG	75.5*29.3*10



### Features

外壳材料 Housing:	Aluminium
灯珠品牌 LED Brands:	Philips / Osram / Bridgelux
光效 Luminous efficiency:	140 lm/W
显色指数 CRI:	70/ 80
色温 Colour temp.:	3000k - 6500K
驱动 LED Driver:	Taiwan MeanWell
功率因数 Power Factor:	>0.95
总谐波失真 THD of Driver:	≤9%
输入电压 Input Voltage:	AC 110-265 V 50-60 Hz
防护等级 Protection:	IP 65
工作环境温度 Working temp.:	-40 ~ +65°C
使用寿命 Life span:	> 50,000 h
光束角 Beam angle:	Type2/Type3/Type4/Type5

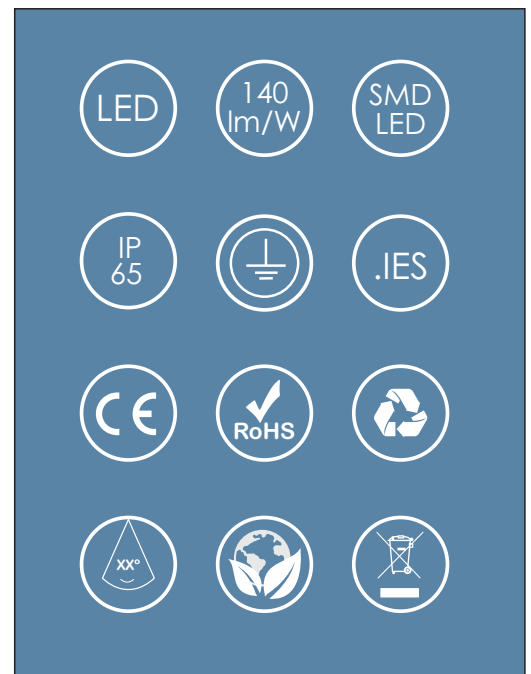

型号 MODEL NUMBER	瓦数 WATTAGE	光通总量 NOMINAL FLUX	净重 N.W.	毛重 G.W.	产品尺寸 (CM) Product. SIZE (CM)
VIS-FLL- 50W-01	50 W	7000 LM	2.3 KG	2.6 KG	42.5*20*12.1
VIS-FLL-100W-01	100 W	14000 LM	3.1 KG	3.4 KG	54*25.6*12.5
VIS-FLL-150W-01	150 W	21000 LM	3.8 KG	4.3 KG	59.9*25.6*12.5





## Features

外壳材料 Housing:	Aluminium
灯珠品牌 LED Brands:	Philips / Osram / Bridgelux
光效 Luminous efficiency:	135 lm/W
显色指数 CRI:	70/ 80
色温 Colour temp.:	3000k - 6500K
驱动 LED Driver:	Taiwan MeanWell
功率因数 Power Factor:	>0.95
总谐波失真 THD of Driver:	≤9%
输入电压 Input Voltage:	AC 110-265 V 50-60 Hz
防护等级 Protection:	IP 66
工作环境温度 Working temp.:	-40 ~ +65°C
使用寿命 Life span:	> 50,000 h
光束角 Beam angle:	65*150°/80*150°

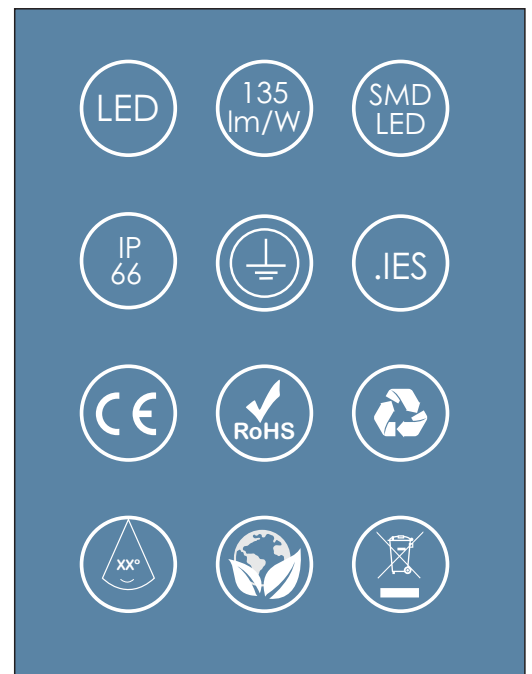

型号 MODEL NUMBER	瓦数 WATTAGE	光通总量 NOMINAL FLUX	净重 N.W.	毛重 G.W.	产品尺寸 (CM) Product. SIZE (CM)
VIS-FLC- 50W	50 W	6750 LM	3.1 KG	4.2 KG	47*18*8.5
VIS-FLC-100W	100 W	13500 LM	4.2 KG	5.4 KG	54*25*9.5
VIS-FLC-150W	150 W	20250 LM	4.9 KG	6.3 KG	73*30.5*11



## Features

外壳材料 Housing:	Aluminium
灯珠品牌 LED Brands:	Philips / Osram / Bridgelux
光效 Luminous efficiency:	120 lm/W
显色指数 CRI:	70/ 80
色温 Colour temp.:	3000k - 6500K
驱动 LED Driver:	Taiwan MeanWell
功率因数 Power Factor:	>0.95
总谐波失真 THD of Driver:	≤9%
输入电压 Input Voltage:	AC 110-265 V 50-60 Hz
防护等级 Protection:	IP 66
工作环境温度 Working temp.:	-40 ~ +65°C
使用寿命 Life span:	> 50,000 h
光束角 Beam angle:	70*140°

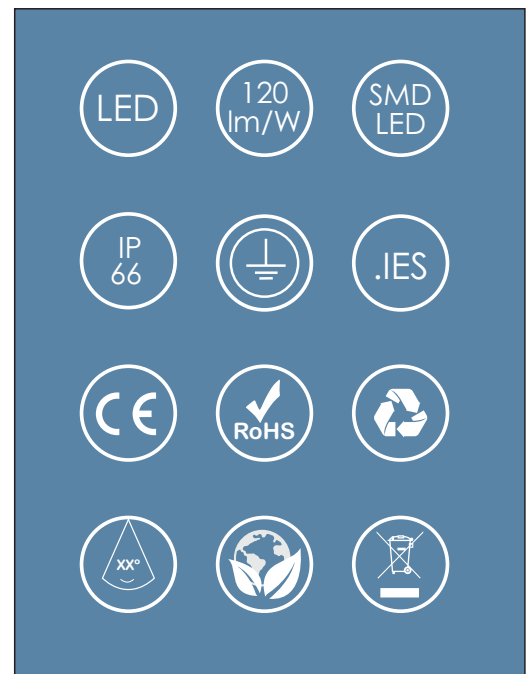

型号 MODEL NUMBER	瓦数 WATTAGE	光通总量 NOMINAL FLUX	净重 N.W.	毛重 G.W.	产品尺寸 (CM) Product. SIZE (CM)
VIS-FLC-100W-01	100 W	12000 LM	5.2 KG	6.1 KG	30.5*52.5*11
VIS-FLC-150W-01	150 W	18000 LM	6.5 KG	7.6 KG	30.5*60.5*11
VIS-FLC-200W-01	200 W	24000 LM	7.1 KG	8.3 KG	30.5*73*11

LED STREET LIGHT 路灯款式



VIS-01



VIS-02



VIS-03



VIS-04



VIS-05



VIS-06



VIS-07



VIS-08



VIS-09



VIS-10



VIS-11



VIS-12

LED STREET LIGHT 太阳能路灯款式



VIS-TYN-01



VIS-TYN-02



VIS-TYN-03



VIS-TYN-04



VIS-TYN-05



VIS-TYN-06



VIS-TYN-07



VIS-TYN-08



**VISLIGHTING**  
维士照明®

# LED EXPLOSION PROOF LIGHT

防爆灯系列

50-200W

PCEC explosion proof certification  
5 years warranty





## Features

外壳材料 Housing:	Aluminium
灯珠品牌 LED Brands:	Bridgelux
光效 Luminous efficiency:	135 lm/W
显色指数 CRI:	70/ 80
色温 Colour temp.:	2700k - 6000K
驱动 LED Driver:	Specialized Power
功率因数 Power Factor:	>0.95
总谐波失真 THD of Driver:	≤9%
输入电压 Input Voltage:	AC 85-265 V 50-60 Hz
防护等级 Protection:	IP 66
工作环境温度 Working temp.:	-40 ~ +60°C
使用寿命 Life span:	> 50,000 h
电器类型 Appliance:	Exd II C T6 Gb
光束角 Beam angle:	90°/ 120°

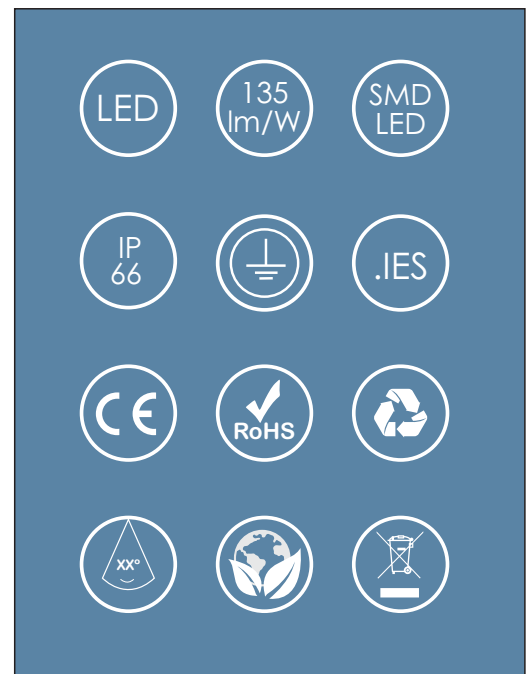

型号 MODEL NUMBER	瓦数 WATTAGE	光通总量 NOMINAL FLUX	净重 N.W.	毛重 G.W.	产品尺寸 (CM) Product SIZE (CM)
VIS-50W.FB	50 W	6750 LM	4.2 KG	5.3 KG	20*20*27
VIS-100W.FB	100 W	13500 LM	5.8 KG	6.9 KG	25*25*28.5
VIS-150W.FB	150 W	20250 LM	8.5 KG	9.6 KG	32*32*31
VIS-200W.FB	200 W	27000 LM	8.5 KG	9.6 KG	32*32*31



## Features

外壳材料 Housing:	Aluminium
灯珠品牌 LED Brands:	Bridgelux
光效 Luminous efficiency:	140 lm/W
显色指数 CRI:	70/ 80
色温 Colour temp.:	2700k - 6000K
驱动 LED Driver:	Specialized Power
功率因数 Power Factor:	>0.95
总谐波失真 THD of Driver:	≤9%
输入电压 Input Voltage:	AC 85-265 V 50-60 Hz
防护等级 Protection:	IP 66
工作环境温度 Working temp.:	-40 ~ +60°C
使用寿命 Life span:	> 50,000 h
电器类型 Appliance:	Exd II C T6 Gb
光束角 Beam angle:	90°/ 120°

型号 MODEL NUMBER	瓦数 WATTAGE	光通总量 NOMINAL FLUX	净重 N.W.	毛重 G.W.	产品尺寸 (CM) Product SIZE (CM)
VIS-50W.FB-01	50 W	7000 LM	3.55 KG	4.0 KG	25*17*13
VIS-100W.FB-01	100 W	14000 LM	6.20 KG	6.6 KG	32*32*16
VIS-150W.FB-01	150 W	21000 LM	12.5 KG	13.5 KG	46*31*20
VIS-200W.FB-01	200 W	28000 LM	12.5 KG	13.5 KG	46*31*20



## Features

外壳材料 Housing:	Aluminium
灯珠品牌 LED Brands:	Bridgelux
光效 Luminous efficiency:	140 lm/W
显色指数 CRI:	70/ 80
色温 Colour temp.:	3000k - 6000K
驱动 LED Driver:	External power supply
功率因数 Power Factor:	>0.95
总谐波失真 THD of Driver:	≤9%
输入电压 Input Voltage:	AC 85-265 V 50-60 Hz
防护等级 Protection:	IP 66
工作环境温度 Working temp.:	-40 ~ +60°C
使用寿命 Life span:	> 50,000 h
光束角 Beam angle:	90°/ 120°

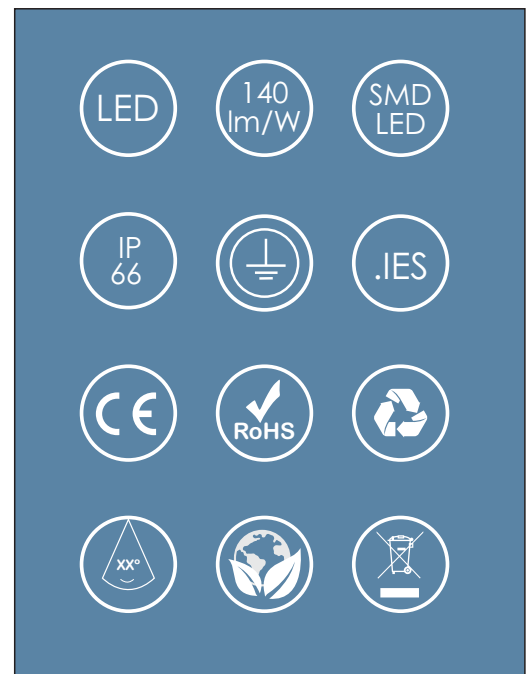

型号 MODEL NUMBER	瓦数 WATTAGE	光通总量 NOMINAL FLUX	净重 N.W.	毛重 G.W.	产品尺寸 (CM) Product SIZE (CM)
VIS-50W.FB-02	50 W	7000 LM	3.55 KG	4.0 KG	25*17*13



**VISLI HTIN**  
维士照明®



## LED HIGH BAY LIGHT

Jupiter款系列工矿灯

50-240W

Anti-glare  
Dustproof

5 years warranty





## Features

外壳材料 Housing:	Aluminium
灯珠品牌 LED Brands:	Philips / Osram / Bridgelux
光效 Luminous efficiency:	125-135 lm/W
显色指数 CRI:	70/ 80
色温 Colour temp.:	2700k - 7000K
驱动 LED Driver:	Taiwan MeanWell
功率因数 Power Factor:	>0.95
总谐波失真 THD of Driver:	≤9%
输入电压 Input Voltage:	AC 110-265 V 50-60 Hz
防护等级 Protection:	IP 65
工作环境温度 Working temp.:	-40 ~ +65°C
使用寿命 Life span:	> 50,000 h
电器类型 Appliance:	Class I
光束角 Beam angle:	60° / 90°

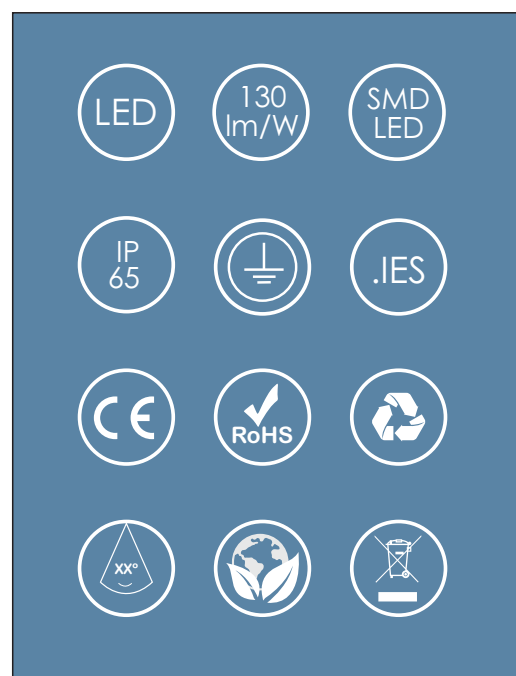

型号 MODEL NUMBER	瓦数 WATTAGE	光通总量 NOMINAL FLUX	净重 N.W.	毛重 G.W.	产品尺寸 (CM) PRODUCT SIZE (CM)
VIS-JHB-50W	50 W	6500 LM	3.4 KG	3.9 KG	28*28*22.6
VIS-JHB-100W	100 W	13000 LM	3.4 KG	3.9 KG	28*28*22.6
VIS-JHB-150W	150 W	19500 LM	4.9 KG	5.4 KG	32.4*32.4*26.3
VIS-JHB-200W	200 W	26000 LM	5.3 KG	5.8 KG	38*38*26.7
VIS-JHB-240W	240 W	31200 LM	5.3 KG	5.8 KG	38*38*26.7



Photometry

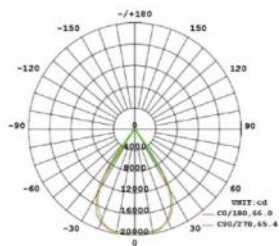

MODULE 60°

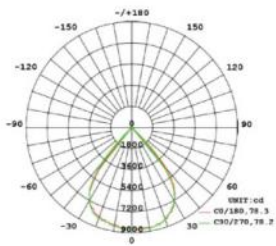

MODULE 90°

Dimensiones/ Measures

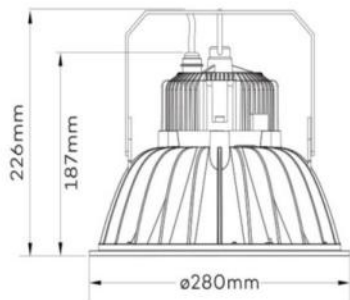

50w / 100 W

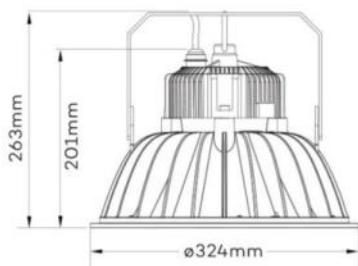

150 W

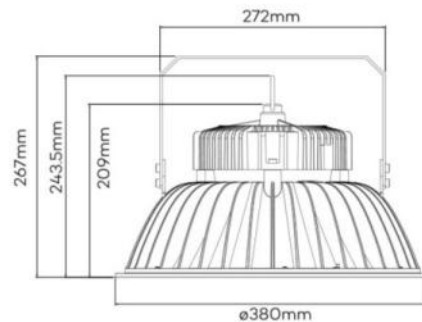

200w / 240 W



## Features

外壳材料 Housing:	Aluminium
灯珠品牌 LED Brands:	Philips / Osram / Bridgelux
光效 Luminous efficiency:	130 lm/W
显色指数 CRI:	70/ 80
色温 Colour temp.:	2700k - 7000K
驱动 LED Driver:	Taiwan MeanWell
功率因数 Power Factor:	>0.95
总谐波失真 THD of Driver:	≤9%
输入电压 Input Voltage:	AC 110-265 V 50-60 Hz
防护等级 Protection:	IP 65
工作环境温度 Working temp.:	-40 ~ +65°C
使用寿命 Life span:	> 50,000 h
电器类型 Appliance:	Class I
光束角 Beam angle:	60° / 90°

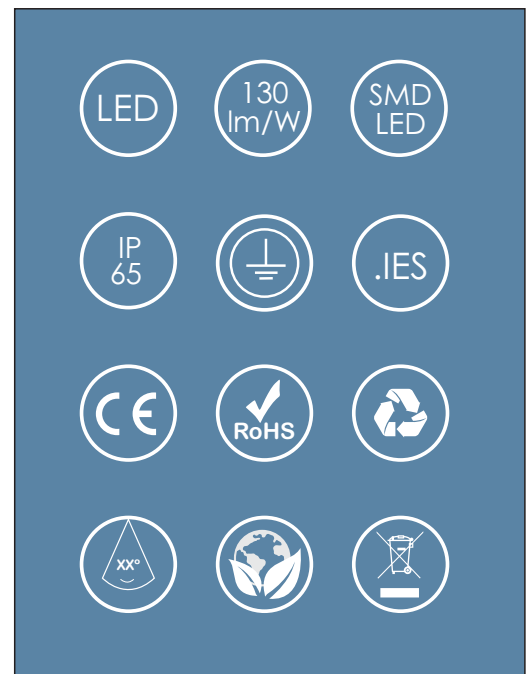

型号 MODEL NUMBER	瓦数 WATTAGE	光通总量 NOMINAL FLUX	净重 N.W.	毛重 G.W.	产品尺寸 (CM) Product SIZE (CM)
VIS-JHB-50W-01	50 W	6500 LM	2.8 KG	3.8 KG	21.5*21.5*9.7
VIS-JHB-100W-01	100 W	13000 LM	3.7 KG	4.8 KG	29*29*15.3
VIS-JHB-150W-01	150 W	19500 LM	4.5 KG	5.9 KG	36.2*36.2*15.3
VIS-JHB-200W-01	200 W	26000 LM	5.2 KG	6.8 KG	40*40*16.3
VIS-JHB-240W-01	240 W	31200 LM	5.2 KG	6.8 KG	40*40*16.3



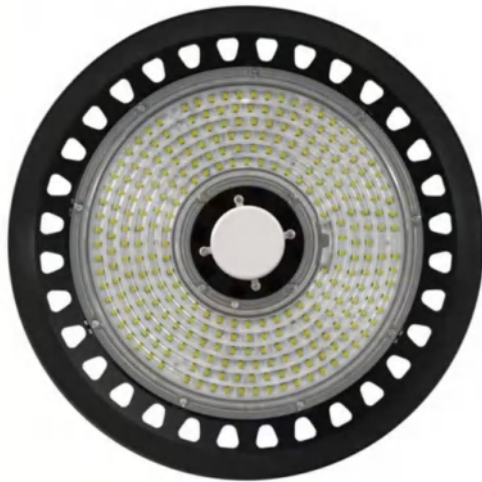

## Features

外壳材料 Housing:	Aluminium
灯珠品牌 LED Brands:	Philips / Osram / Bridgelux
光效 Luminous efficiency:	130 lm/W
显色指数 CRI:	70/ 80
色温 Colour temp.:	2700k - 6500K
驱动 LED Driver:	Domestic
功率因数 Power Factor:	>0.95
总谐波失真 THD of Driver:	≤9%
输入电压 Input Voltage:	AC 110-265 V 50-60 Hz
防护等级 Protection:	IP 65
工作环境温度 Working temp.:	-40 ~ +65°C
使用寿命 Life span:	> 50,000 h
电器类型 Appliance:	Class I
光束角 Beam angle:	60° / 90° / 120°

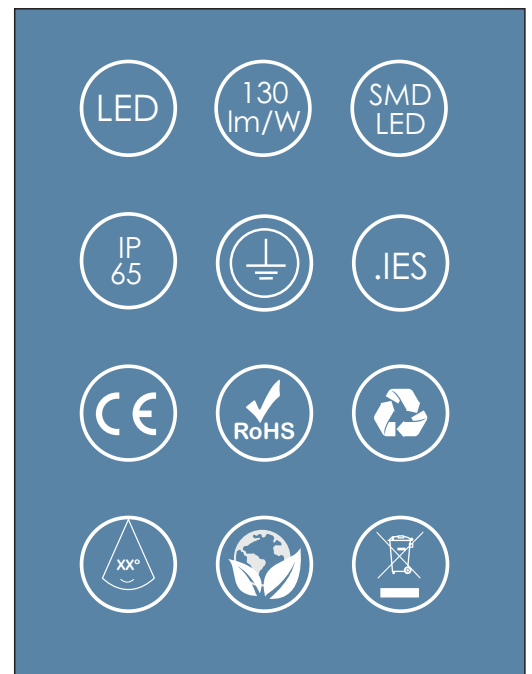

型号 MODEL NUMBER	瓦数 WATTAGE	光通总量 NOMINAL FLUX	净重 N.W.	毛重 G.W.	产品尺寸 (CM) Product SIZE (CM)
VIS-JHB-100W-02	100 W	13000 LM	2.0 KG	3.3 KG	29*29*5
VIS-JHB-150W-02	150 W	19500 LM	3.1 KG	4.5 KG	34*34*5.8
VIS-JHB-200W-02	200 W	26000 LM	3.6 KG	5.1 KG	38*38*6



## Features

外壳材料 Housing:	Aluminium
灯珠品牌 LED Brands:	Philips / Osram / Bridgelux
光效 Luminous efficiency:	110 lm/W
显色指数 CRI:	70/ 80
色温 Colour temp.:	2700k - 7000K
驱动 LED Driver:	Taiwan MeanWell
功率因数 Power Factor:	>0.95
总谐波失真 THD of Driver:	≤9%
输入电压 Input Voltage:	AC 110-265 V 50-60 Hz
防护等级 Protection:	IP 65
工作环境温度 Working temp.:	-40 ~ +65°C
使用寿命 Life span:	> 50,000 h
电器类型 Appliance:	Class I
光束角 Beam angle:	60° / 90° / 120°

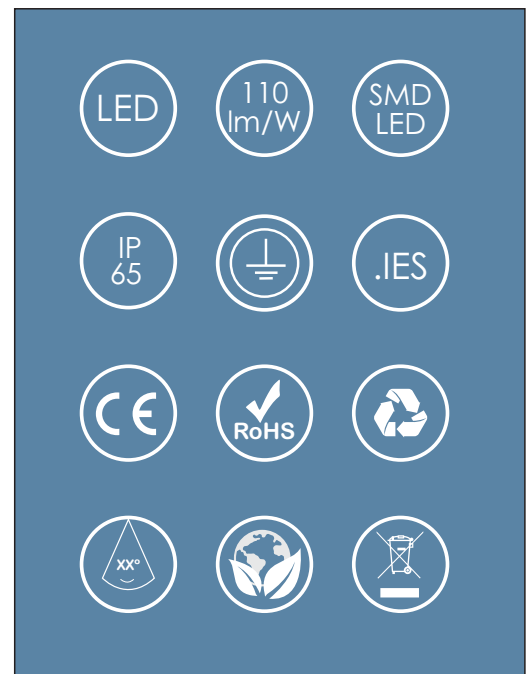

型号 MODEL NUMBER	瓦数 WATTAGE	光通总量 NOMINAL FLUX	净重 N.W.	毛重 G.W.	产品尺寸 (CM) PRODUCT SIZE (CM)
VIS-JHB-100W-03	100 W	11000 LM	1.8 KG	3.1 KG	25*25*5.5
VIS-JHB-150W-03	150 W	16500 LM	2.9 KG	4.2 KG	30*30*5.8
VIS-JHB-200W-03	200 W	22000 LM	3.3 KG	4.8 KG	34.5*34.5*6
VIS-JHB-240W-03	240 W	26400 LM	3.7 KG	5.2 KG	34.5*34.5*6

**VISLIGHTING**  
维士照明®

# LED WALL WASHER LIGHT

洗墙灯

12-36W

Compatible with DMX 512  
Compatible with DALI

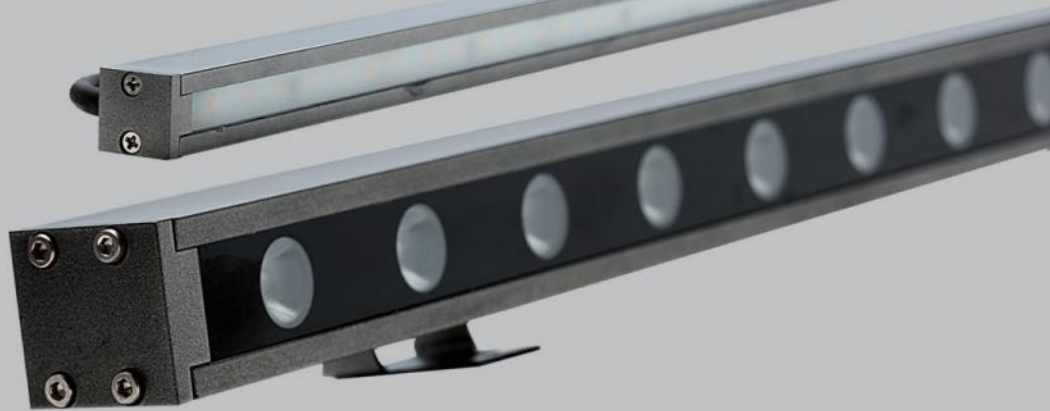
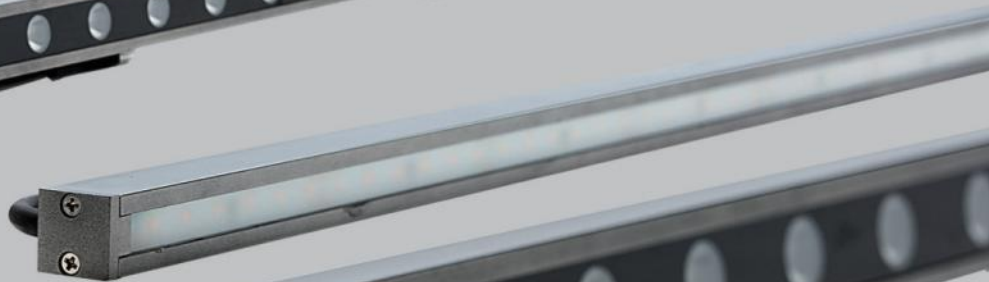

White/RGB/RGBW

3 years warranty



## Features

外壳材料 Housing:	Aluminium
灯珠品牌 LED Brands:	Philips / Osram / Bridgelux
光效 Luminous efficiency:	100 lm/W
显色指数 CRI:	70/ 80
色温 Colour temp:	2700k - 7000K/ RGB
输入电压 Input voltage:	DC 24V
防护等级 Protection:	IP 65
工作环境温度 Working temp. :	-40 ~ +65°C
使用寿命 Life span:	> 50,000 h
电器类型 Appliance:	Class I
光束角 Beam angle:	30°/45°/60°/10X60°/15X50°/30X60°

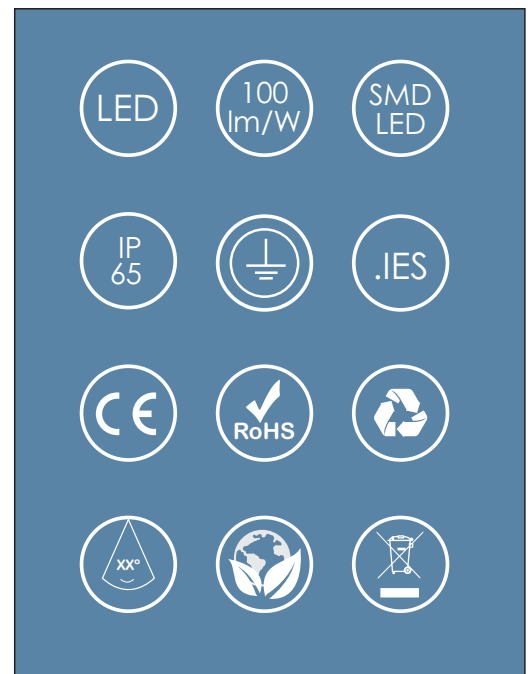

型号 MODEL NUMBER	瓦数 WATTAGE	LED 数量 LED PCS	光通总量 NOMINAL FLUX	净重 N.W.	毛重 G.W.	包装尺寸 (CM) CRT. SIZE (CM)
VIS-WW-12W	12 W	48	1200 LM	1.0 KG	1.3 KG	1050*26*12
VIS-WW-18W	18 W	18	1800 LM	1.6 KG	2.1 KG	1050*28*17
VIS-WW-24W	24 W	24	2400 LM	1.6 KG	2.1 KG	1050*28*17
VIS-WW-36W	36 W	36	3600 LM	2.1 KG	2.7 KG	1050*35*17





Photometry

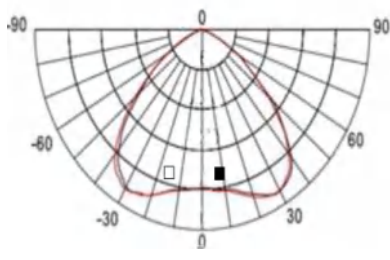

Dimensiones/ Measures

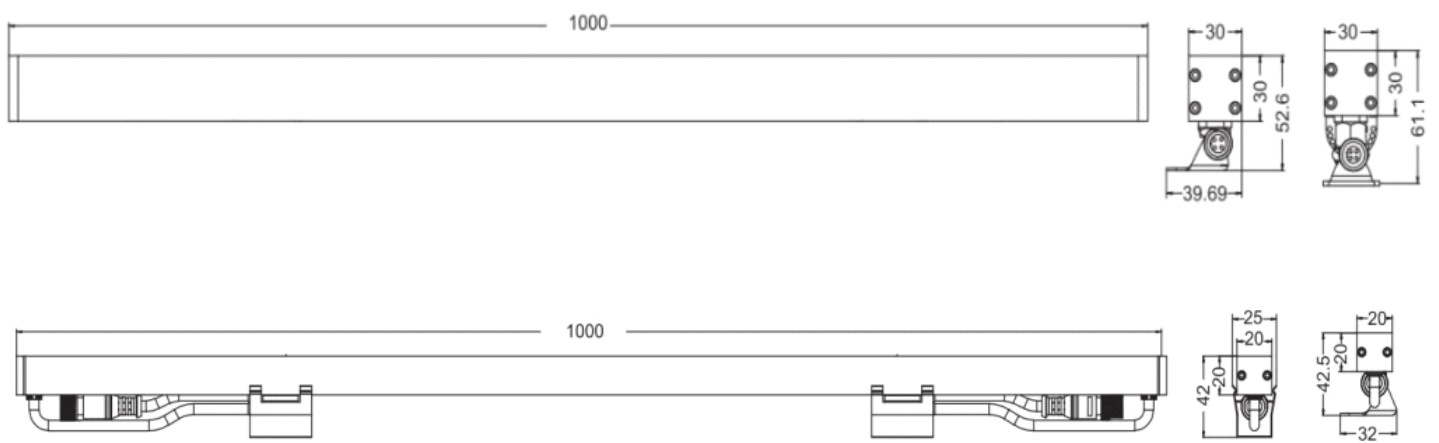



## Features

外壳材料 Housing:	Aluminium
灯珠品牌 LED Brands:	Philips / Osram / Bridgelux
光效 Luminous efficiency:	80 lm/W
显色指数 CRI:	70/ 80
色温 Colour temp.:	2700k - 7000K
驱动 LED Driver:	国产
功率因数 Power Factor:	>0.95
总谐波失真 THD of Driver:	≤9%
输入电压 Input Voltage:	AC 110-265 V 50-60 Hz
防护等级 Protection:	IP 40
工作环境温度 Working temp.:	-40 ~ +65°C
使用寿命 Life span:	> 50,000 h
电器类型 Appliance:	Class I
光束角 Beam angle:	120°

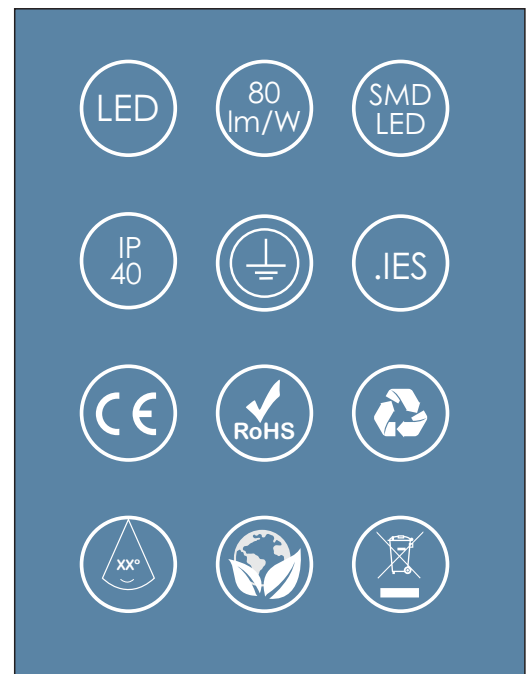

型号 MODEL NUMBER	瓦数 WATTAGE	LED 数量 LED PCS	光通总量 NOMINAL FLUX
VIS-8W-60.A/T5	8 W	120	640 LM
VIS-15W-120.A/T5	15 W	270	1200 LM
VIS-8W-60.A/T8	8 W	174	640 LM
VIS-15W-120.B/T8	15 W	276	1200 LM
VIS-5W-30.C/T8	5 W	103	400 LM



### Features

外壳材料 Housing:	Aluminium
灯珠品牌 LED Brands:	Philips / Osram / Bridgelux
光效 Luminous efficiency:	100 lm/W
显色指数 CRI:	70/ 80
色温 Colour temp.:	2700k - 7000K
驱动 LED Driver:	国产
功率因数 Power Factor:	>0.95
总谐波失真 THD of Driver:	≤9%
输入电压 Input Voltage:	AC 110-265 V 50-60 Hz
防护等级 Protection:	IP 40
工作环境温度 Working temp.:	-40 ~ +65°C
使用寿命 Life span:	> 50,000 h
电器类型 Appliance:	Class I
光束角 Beam angle:	120°

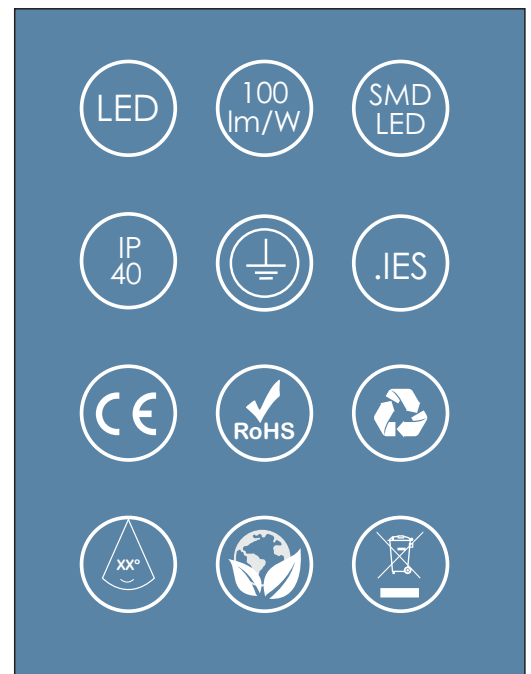

型号 MODEL NUMBER	瓦数 WATTAGE	LED 数量 LED PCS	光通总量 NOMINAL FLUX	包装尺寸 (CM) CRT. SIZE (CM)
VIS-12W.M	12 W	60	1200 LM	20*30*13
VIS-18W.M	18 W	90	1800 LM	30*30*13
VIS-21W.M	21 W	105	2100 LM	30*60*13
VIS-36W.M	36 W	180	3600 LM	60*60*17
VIS-48W.M	48 W	240	4800 LM	60*120*18
VIS-72W.M	72 W	360	7200 LM	60*120*18
VIS-90W.M	90 W	450	9000 LM	60*120*18

# PROJECTS DISPLAY 产品案例展示

## LED Flood Light 投光灯

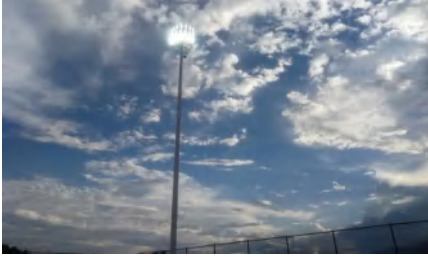

## LED High Bay Light 工矿灯

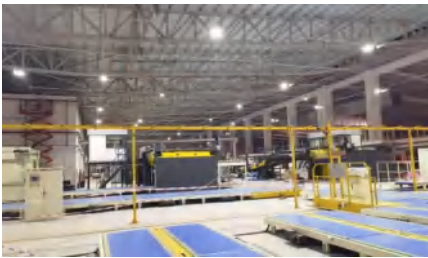

## LED Explosion Proof Light 防爆灯





# PROJECTS DISPLAY 产品案例展示

## LED Stadium Light 球场灯



## LED Street Light 路灯/LED Tunnel Light 隧道灯

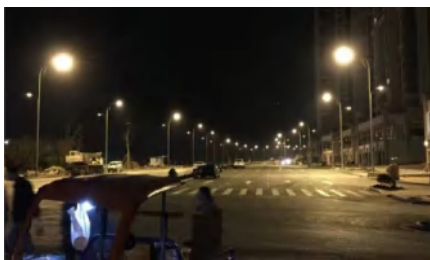
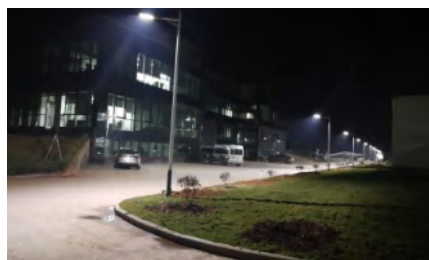
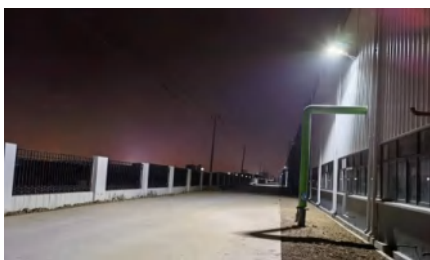

## LED Heat Resistance Light 耐高温灯

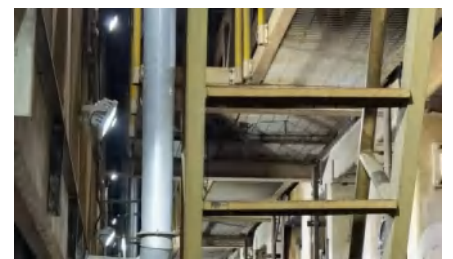
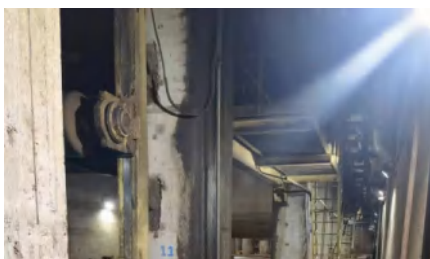

## LED Wall Washer Light 洗墙灯/ Tube Light 灯管/ Panel Light 面板灯

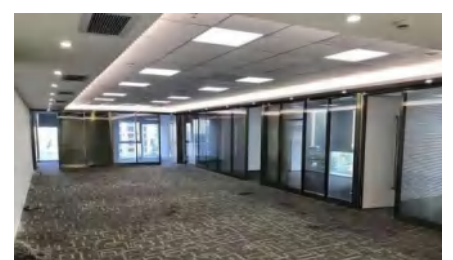
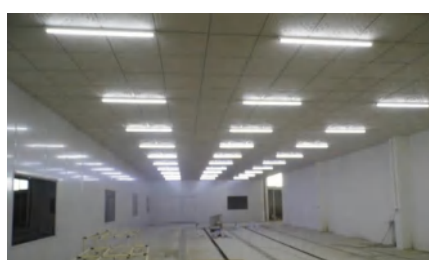
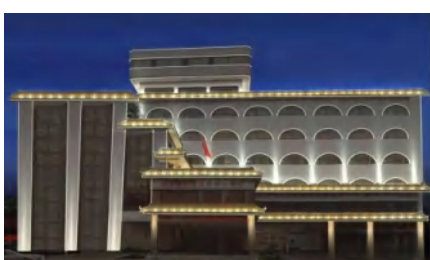

# CERTIFICATE



[www.vislighting.com](http://www.vislighting.com)

ADD: 广东省东莞市厚街镇厚福路3号1号楼201室

Room 201, second floor, Building 1,

No.3 Houfu Road, Houjie Town,

Dongguan City, Guangdong Province, China

Tel: +86 769 23094703

Fax: +86 769 23094713

E-mail: [info@vislighting.com](mailto:info@vislighting.com)

